

William Stallings

Data and Computer

Communications

7th Edition

Chapter 4

Transmission Media

Overview

- Guided - wire
- Unguided - wireless
- Characteristics and quality determined by medium and signal
- For guided, the medium is more important
- For unguided, the bandwidth produced by the antenna is more important
- Key concerns are data rate and distance

Design Factors

- Bandwidth
 - Higher bandwidth gives higher data rate
- Transmission impairments
 - Attenuation
- Interference
- Number of receivers
 - In guided media
 - More receivers (multi-point) introduce more attenuation

Electromagnetic Spectrum

Frequency
(Hertz)

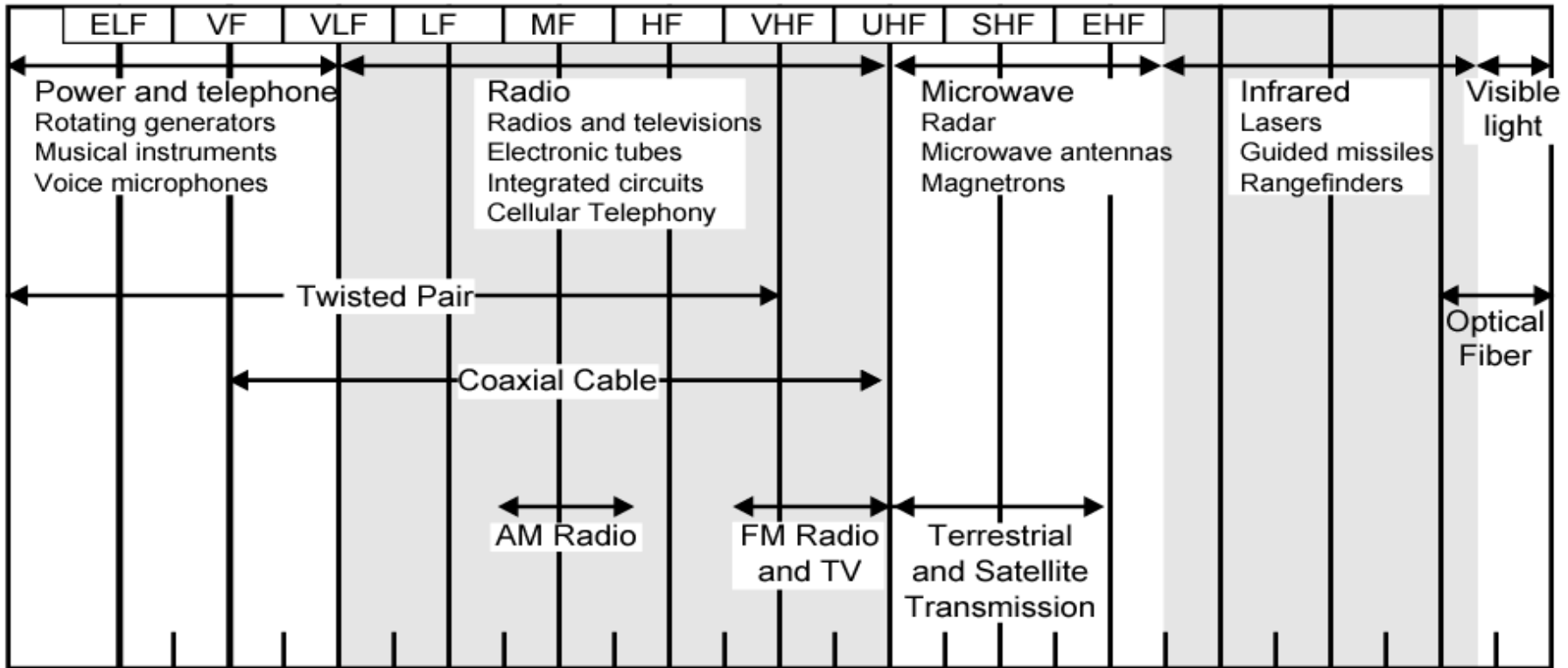

Wavelength
in space
(meters)

ELF = Extremely low frequency
VF = Voice frequency
VLF = Very low frequency
LF = Low frequency

MF = Medium frequency
HF = High frequency
VHF = Very high frequency

UHF = Ultrahigh frequency
SHF = Superhigh frequency
EHF = Extremely high frequency

Guided Transmission Media

- Twisted Pair
- Coaxial cable
- Optical fiber

Transmission Characteristics of Guided Media

	Frequency Range	Typical Attenuation	Typical Delay	Repeater Spacing
Twisted pair (with loading)	0 to 3.5 kHz	0.2 dB/km @ 1 kHz	50 μ s/km	2 km
Twisted pairs (multi-pair cables)	0 to 1 MHz	0.7 dB/km @ 1 kHz	5 μ s/km	2 km
Coaxial cable	0 to 500 MHz	7 dB/km @ 10 MHz	4 μ s/km	1 to 9 km
Optical fiber	186 to 370 THz	0.2 to 0.5 dB/km	5 μ s/km	40 km

Twisted Pair

- Separately insulated
- Twisted together
- Often "bundled" into cables
- Usually installed in building during construction

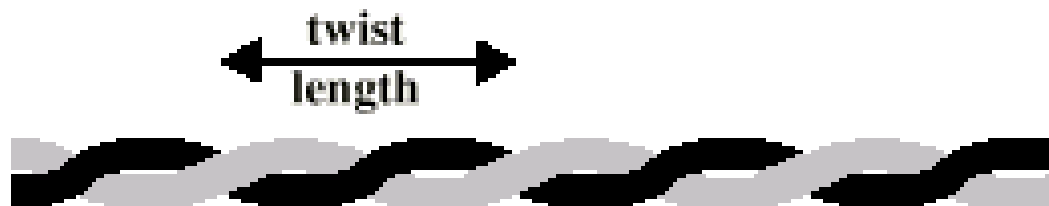

(a) Twisted pair

Twisted Pair - Applications

- Most common medium
- Telephone network
 - Between house and local exchange (subscriber loop)
- Within buildings
 - To private branch exchange (PBX)
- For local area networks (LAN)
 - 10Mbps or 100Mbps

Twisted Pair - Pros and Cons

- Cheap
- Easy to work with
- Low data rate
- Short range

Twisted Pair - Transmission Characteristics

- Analog
 - Amplifiers every 5km to 6km
- Digital
 - Use either analog or digital signals
 - repeater every 2km or 3km
- Limited distance
- Limited bandwidth (1MHz)
- Limited data rate (100MHz)
- Susceptible to interference and noise

Near End Crosstalk

- Coupling of signal from one pair to another
- Coupling takes place when transmit signal entering the link couples back to receiving pair
- i.e. near transmitted signal is picked up by near receiving pair

Unshielded and Shielded TP

- Unshielded Twisted Pair (UTP)
 - Ordinary telephone wire
 - Cheapest
 - Easiest to install
 - Suffers from external EM interference
- Shielded Twisted Pair (STP)
 - Metal braid or sheathing that reduces interference
 - More expensive
 - Harder to handle (thick, heavy)

UTP Categories

- Cat 3
 - up to 16MHz
 - Voice grade found in most offices
 - Twist length of 7.5 cm to 10 cm
- Cat 4
 - up to 20 MHz
- Cat 5
 - up to 100MHz
 - Commonly pre-installed in new office buildings
 - Twist length 0.6 cm to 0.85 cm
- Cat 5E (Enhanced) –see tables
- Cat 6
- Cat 7

Comparison of Shielded and Unshielded Twisted Pair

	Attenuation (dB per 100 m)			Near-end Crosstalk (dB)		
Frequency (MHz)	Category 3 UTP	Category 5 UTP	150-ohm STP	Category 3 UTP	Category 5 UTP	150-ohm STP
1	2.6	2.0	1.1	41	62	58
4	5.6	4.1	2.2	32	53	58
16	13.1	8.2	4.4	23	44	50.4
25	—	10.4	6.2	—	41	47.5
100	—	22.0	12.3	—	32	38.5
300	—	—	21.4	—	—	31.3

Twisted Pair Categories and Classes

	Category 3 Class C	Category 5 Class D	Category 5E	Category 6 Class E	Category 7 Class F
Bandwidth	16 MHz	100 MHz	100 MHz	200 MHz	600 MHz
Cable Type	UTP	UTP/FTP	UTP/FTP	UTP/FTP	SSTP
Link Cost (Cat 5 =1)	0.7	1	1.2	1.5	2.2

Coaxial Cable

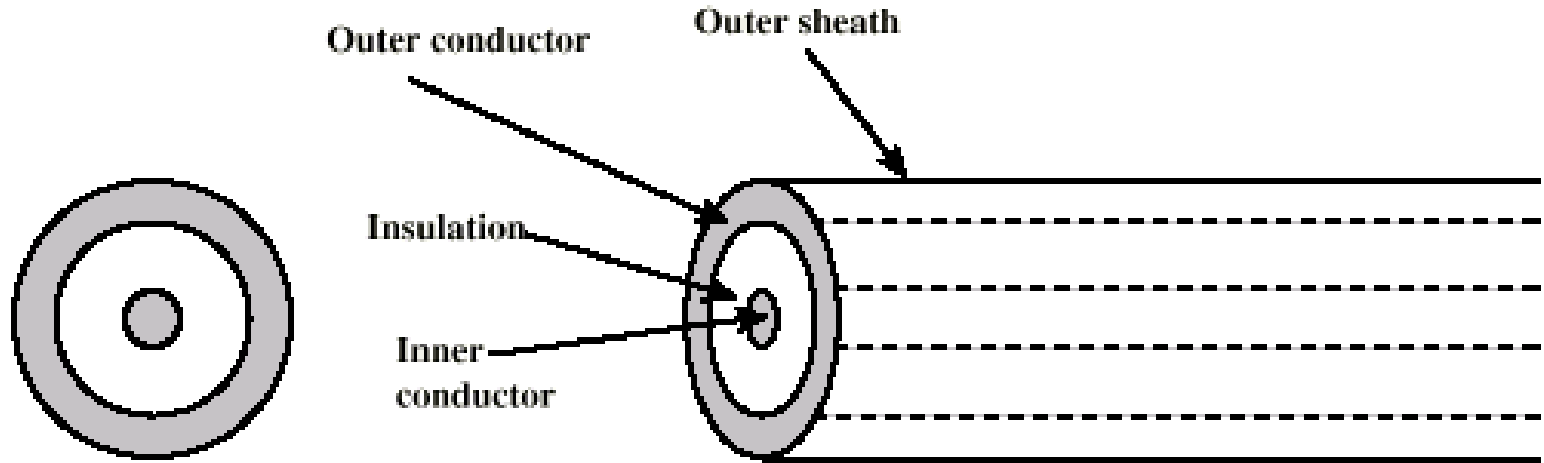

- Outer conductor is braided shield
- Inner conductor is solid metal
- Separated by insulating material
- Covered by padding

Coaxial Cable Applications

- Most versatile medium
- Television distribution
 - Ariel to TV
 - Cable TV
- Long distance telephone transmission
 - Can carry 10,000 voice calls simultaneously
 - Being replaced by fiber optic
- Short distance computer systems links
- Local area networks

Coaxial Cable - Transmission Characteristics

- Analog
 - Amplifiers every few km
 - Closer if higher frequency
 - Up to 500MHz
- Digital
 - Repeater every 1km
 - Closer for higher data rates

Optical Fiber

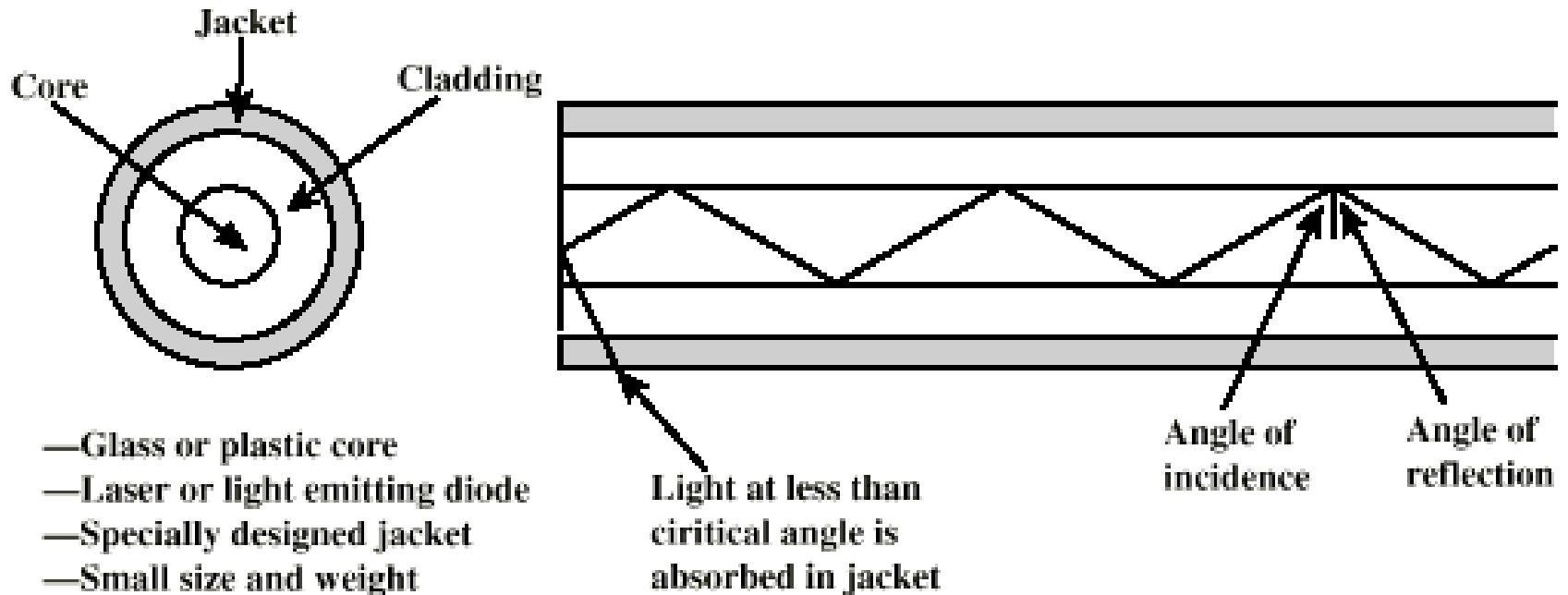

Optical Fiber - Benefits

- Greater capacity
 - Data rates of hundreds of Gbps
- Smaller size & weight
- Lower attenuation
- Electromagnetic isolation
- Greater repeater spacing
 - 10s of km at least

Optical Fiber - Applications

- Long-haul trunks
- Metropolitan trunks
- Rural exchange trunks
- Subscriber loops
- LANs

Optical Fiber - Transmission Characteristics

- Act as wave guide for 10^{14} to 10^{15} Hz
 - Portions of infrared and visible spectrum
- Light Emitting Diode (LED)
 - Cheaper
 - Wider operating temp range
 - Last longer
- Injection Laser Diode (ILD)
 - More efficient
 - Greater data rate
- Wavelength Division Multiplexing

Optical Fiber Transmission Modes

Input pulse

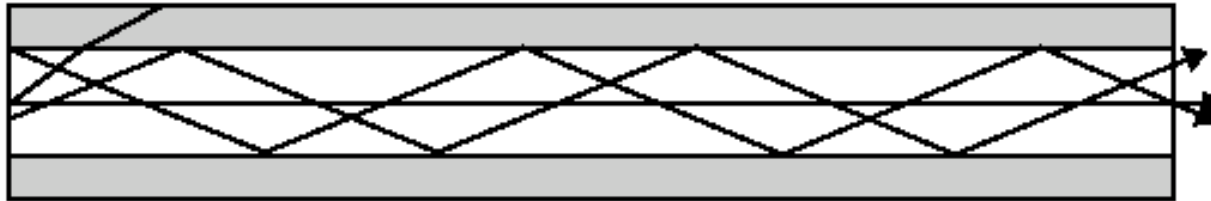

Output pulse

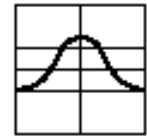

(a) Step-index multimode

Input pulse

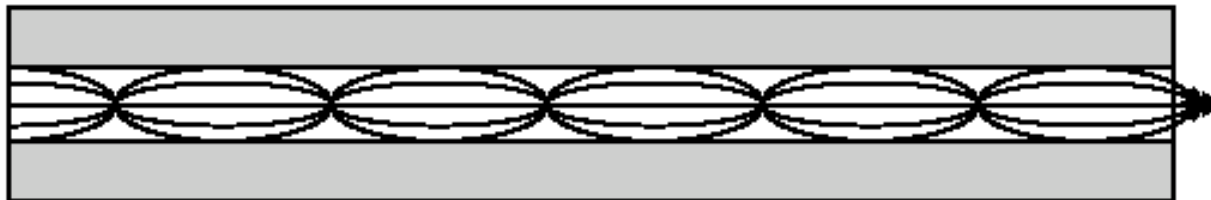

Output pulse



(b) Graded-index multimode

Input pulse

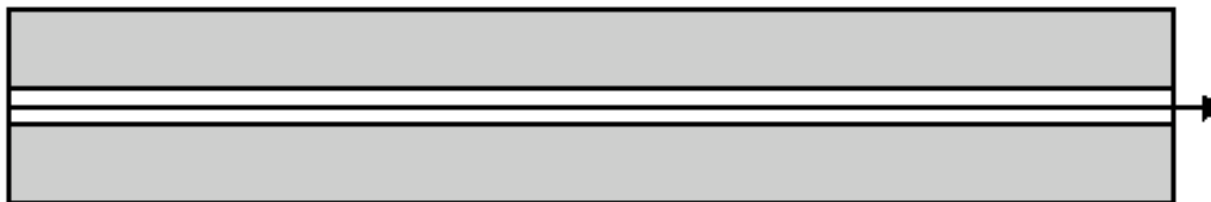
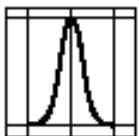

Output pulse

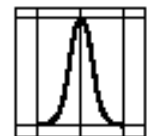

(c) Single mode

Frequency Utilization for Fiber Applications

Wavelength (in vacuum) range (nm)	Frequency range (THz)	Band label	Fiber type	Application
820 to 900	366 to 333		Multimode	LAN
1280 to 1350	234 to 222	S	Single mode	Various
1528 to 1561	196 to 192	C	Single mode	WDM
1561 to 1620	185 to 192	L	Single mode	WDM

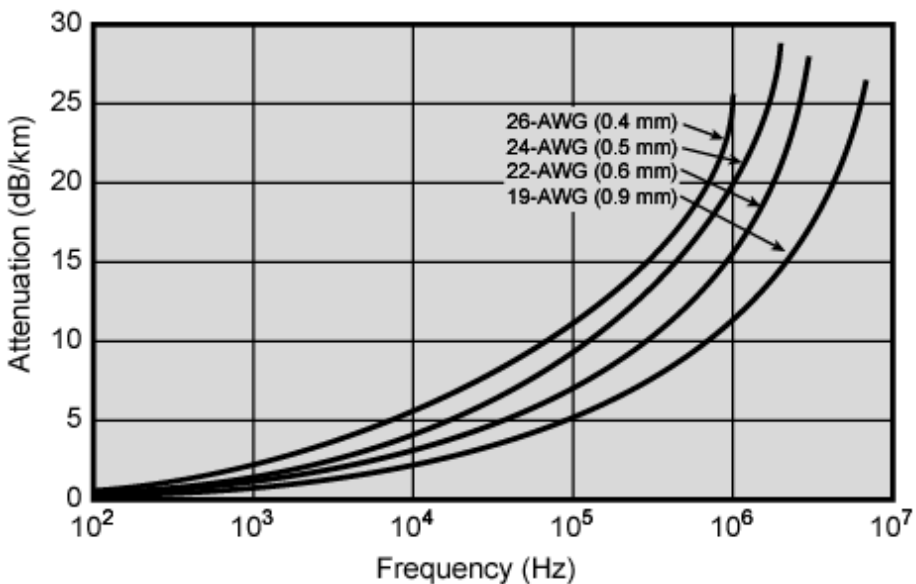

(a) Twisted pair (based on [REEV95])

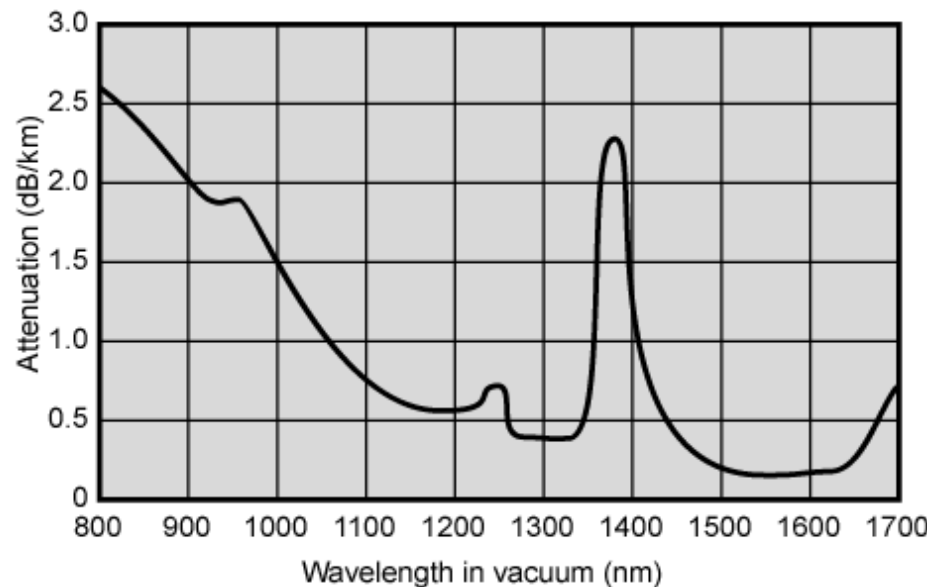

(c) Optical fiber (based on [FREE02])

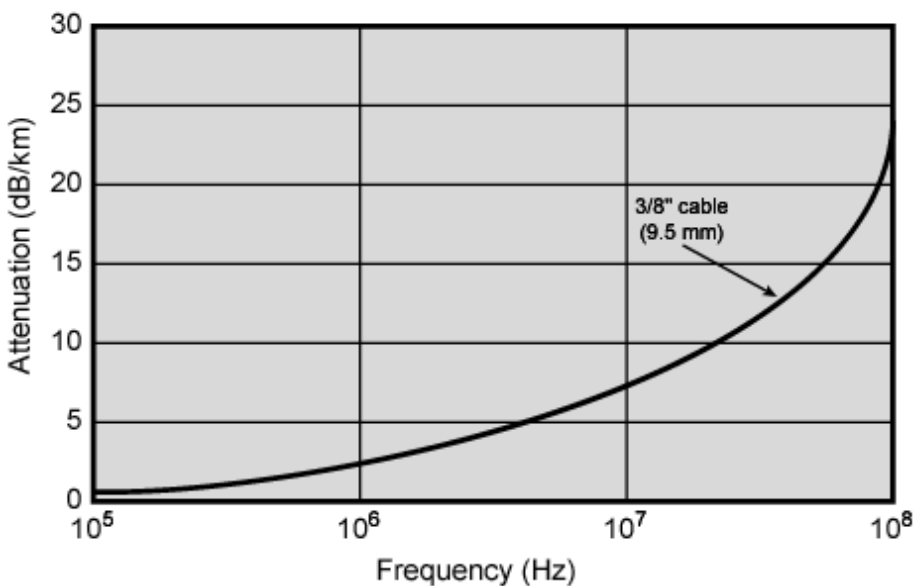

(b) Coaxial cable (based on [BELL90])

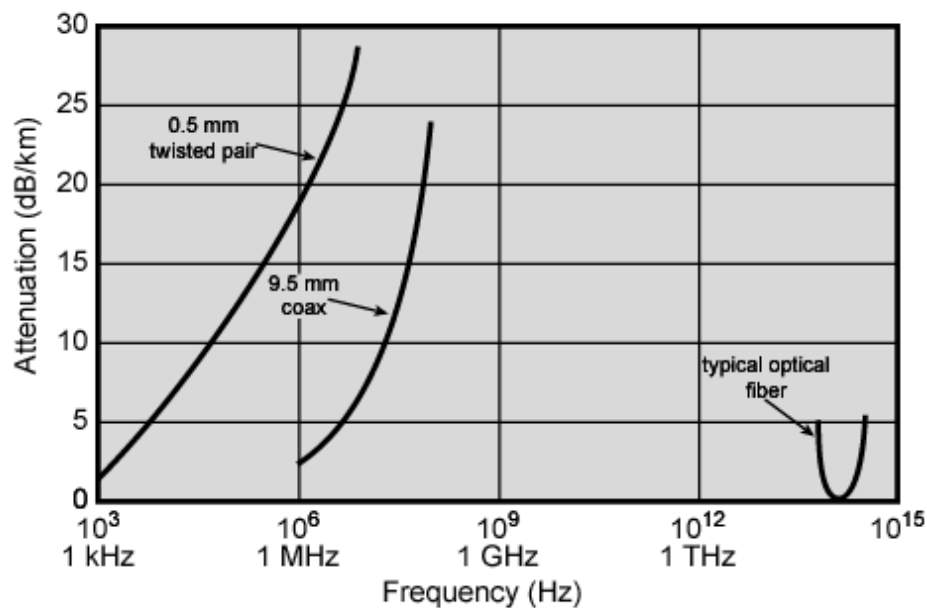

(d) Composite graph

Wireless Transmission Frequencies

- 2GHz to 40GHz
 - Microwave
 - Highly directional
 - Point to point
 - Satellite
- 30MHz to 1GHz
 - Omnidirectional
 - Broadcast radio
- 3×10^{11} to 2×10^{14}
 - Infrared
 - Local

Antennas

- Electrical conductor (or system of..) used to radiate electromagnetic energy or collect electromagnetic energy
- Transmission
 - Radio frequency energy from transmitter
 - Converted to electromagnetic energy
 - By antenna
 - Radiated into surrounding environment
- Reception
 - Electromagnetic energy impinging on antenna
 - Converted to radio frequency electrical energy
 - Fed to receiver
- Same antenna often used for both

Radiation Pattern

- Power radiated in all directions
- Not same performance in all directions
- Isotropic antenna is (theoretical) point in space
 - Radiates in all directions equally
 - Gives spherical radiation pattern

Parabolic Reflective Antenna

- Used for terrestrial and satellite microwave
- Parabola is locus of point equidistant from a line and a point not on that line
 - Fixed point is focus
 - Line is directrix
- Revolve parabola about axis to get paraboloid
 - Cross section parallel to axis gives parabola
 - Cross section perpendicular to axis gives circle
- Source placed at focus will produce waves reflected from parabola in parallel to axis
 - Creates (theoretical) parallel beam of light/sound/radio
- On reception, signal is concentrated at focus, where detector is placed

Parabolic Reflective Antenna

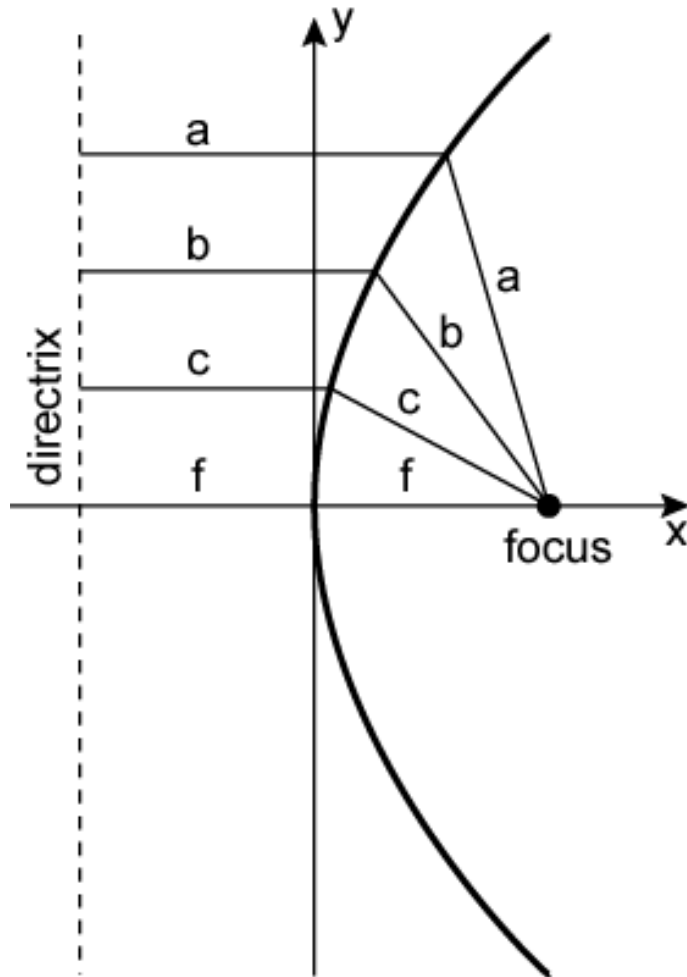

(a) Parabola

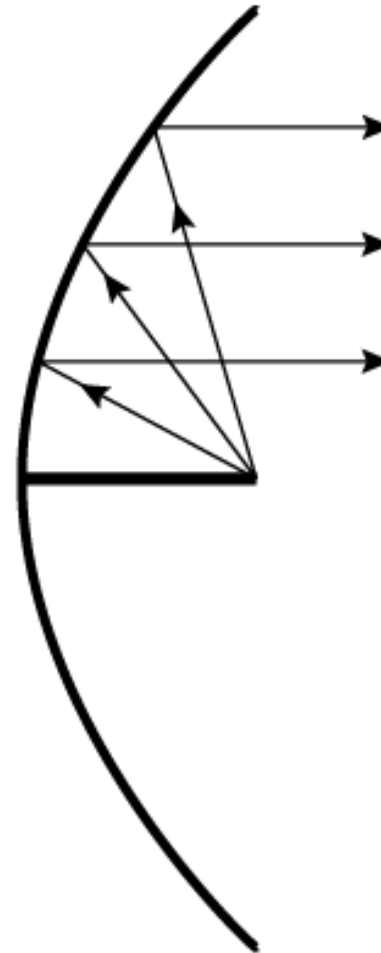

(b) Cross-section of parabolic antenna showing reflective property

Antenna Gain

- Measure of directionality of antenna
- Power output in particular direction compared with that produced by isotropic antenna
- Measured in decibels (dB)
- Results in loss in power in another direction
- Effective area relates to size and shape
 - Related to gain

Terrestrial Microwave

- Parabolic dish
- Focused beam
- Line of sight
- Long haul telecommunications
- Higher frequencies give higher data rates

Satellite Microwave

- Satellite is relay station
- Satellite receives on one frequency, amplifies or repeats signal and transmits on another frequency
- Requires geo-stationary orbit
 - Height of 35,784km
- Television
- Long distance telephone
- Private business networks

Satellite Point to Point Link

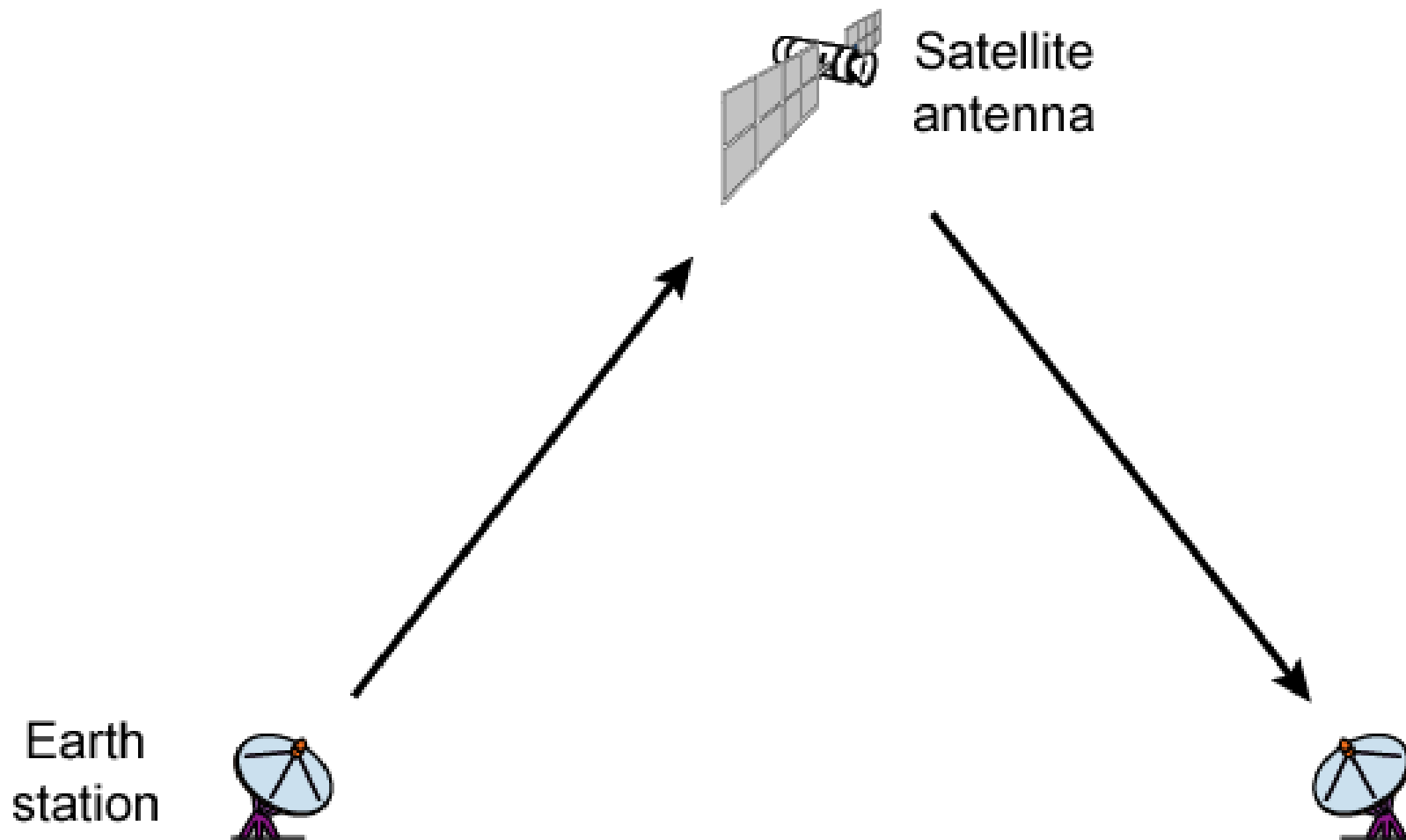

(a) Point-to-point link

Satellite Broadcast Link

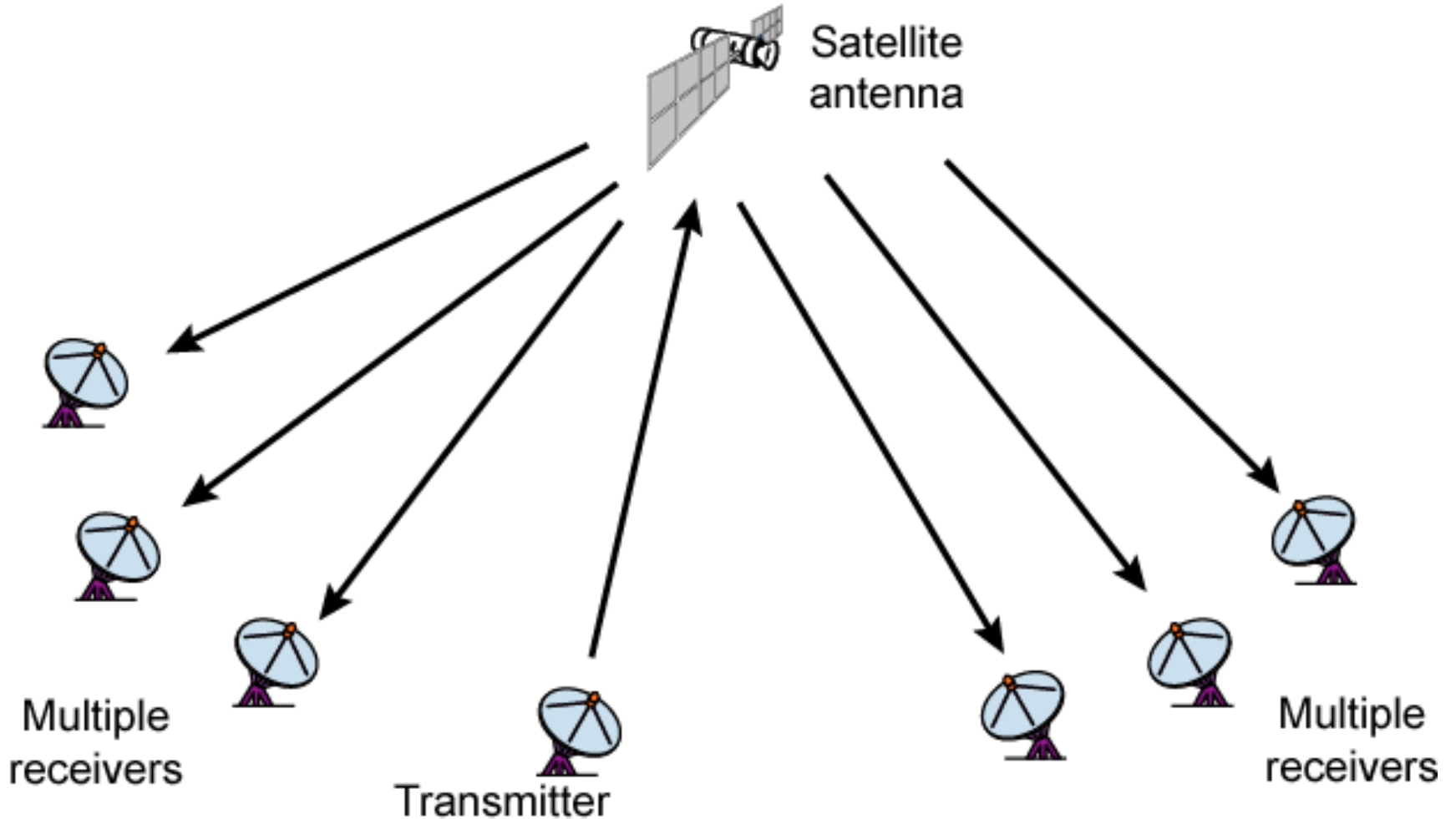

(b) Broadcast link

Broadcast Radio

- Omnidirectional
- FM radio
- UHF and VHF television
- Line of sight
- Suffers from multipath interference
 - Reflections

Infrared

- Modulate noncoherent infrared light
- Line of sight (or reflection)
- Blocked by walls
- e.g. TV remote control, IRD port

Wireless Propagation

- Signal travels along three routes
 - Ground wave
 - Follows contour of earth
 - Up to 2MHz
 - AM radio
 - Sky wave
 - Amateur radio, BBC world service, Voice of America
 - Signal reflected from ionosphere layer of upper atmosphere
 - (Actually refracted)
 - Line of sight
 - Above 30Mhz
 - May be further than optical line of sight due to refraction
 - More later...

Ground Wave Propagation

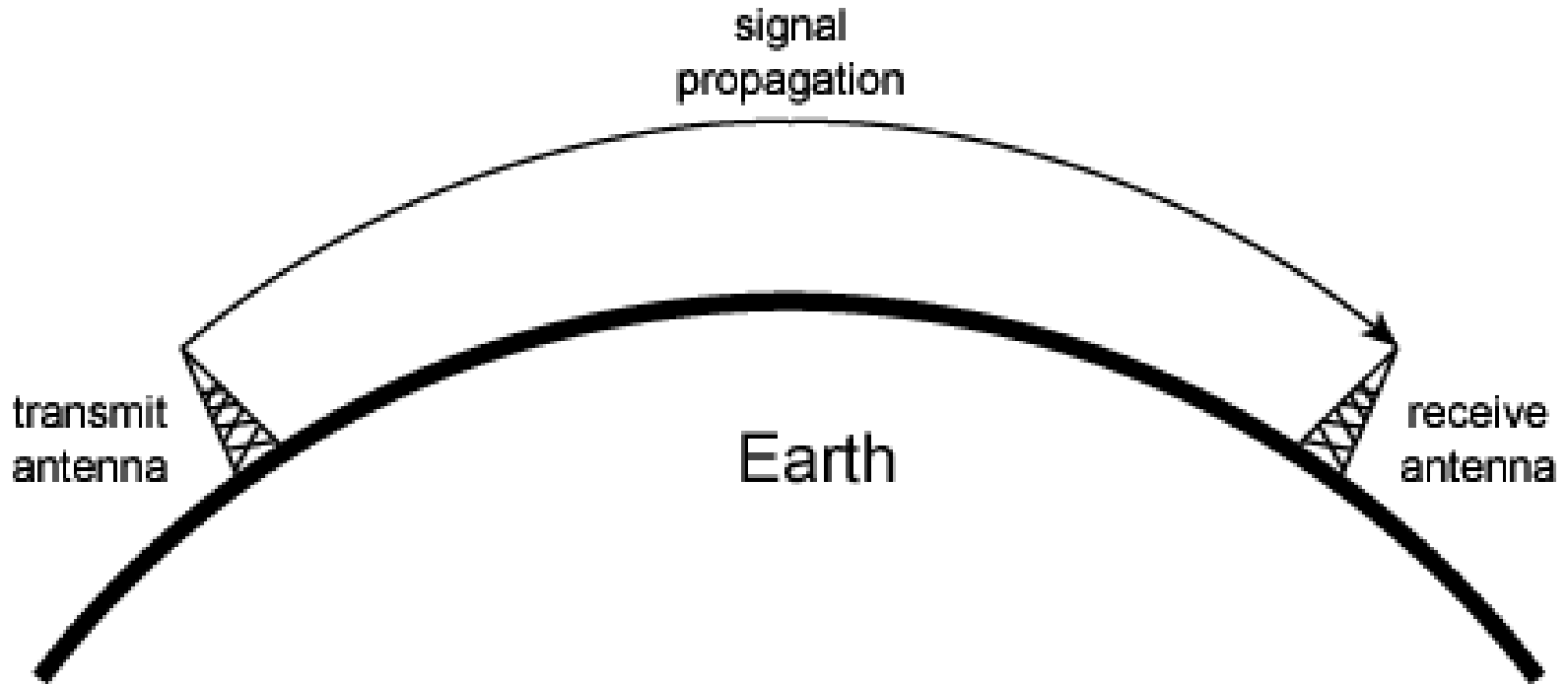

(a) Ground-wave propagation (below 2 MHz)

Sky Wave Propagation

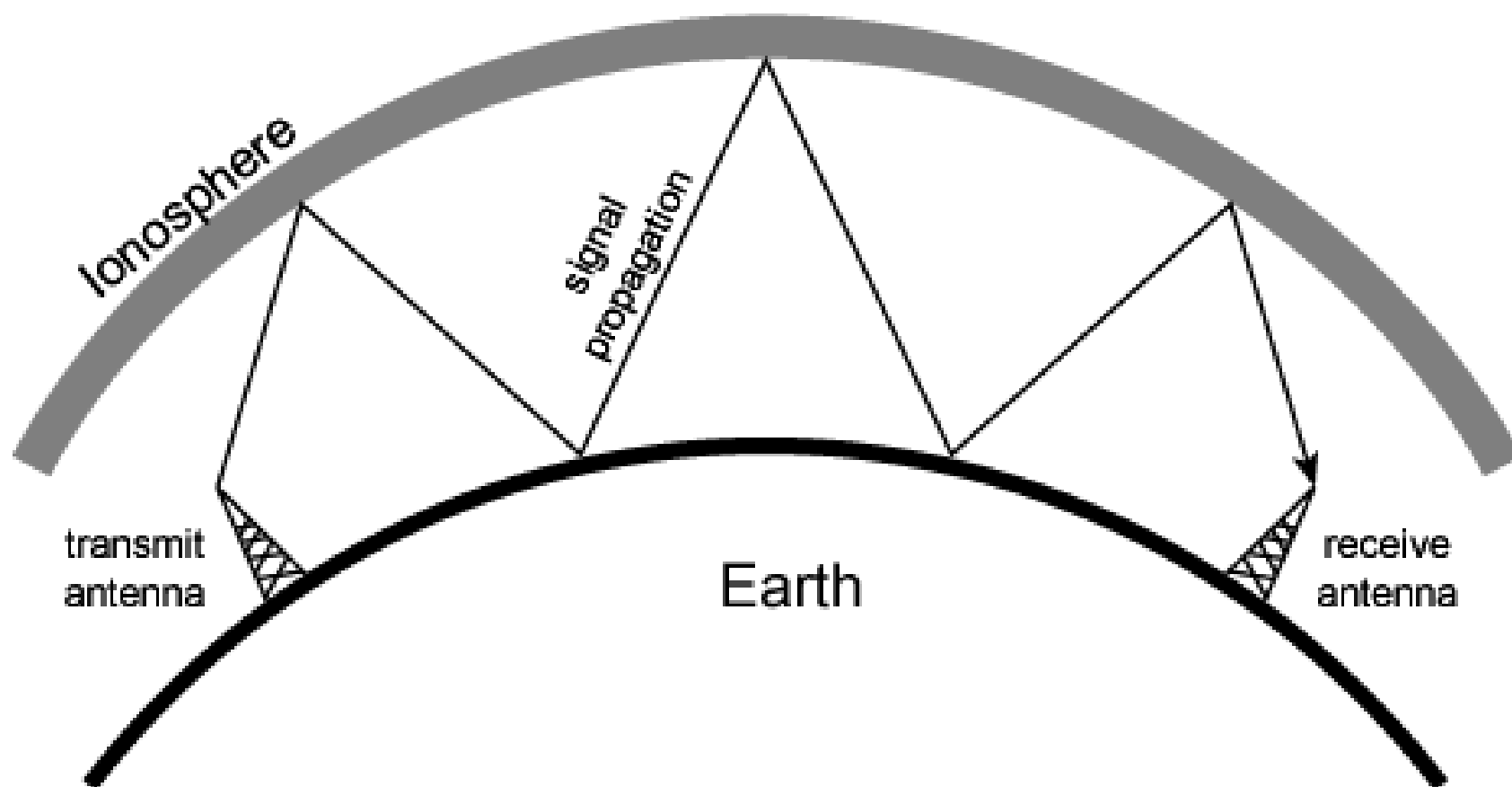

(b) Sky-wave propagation (2 to 30 MHz)

Line of Sight Propagation

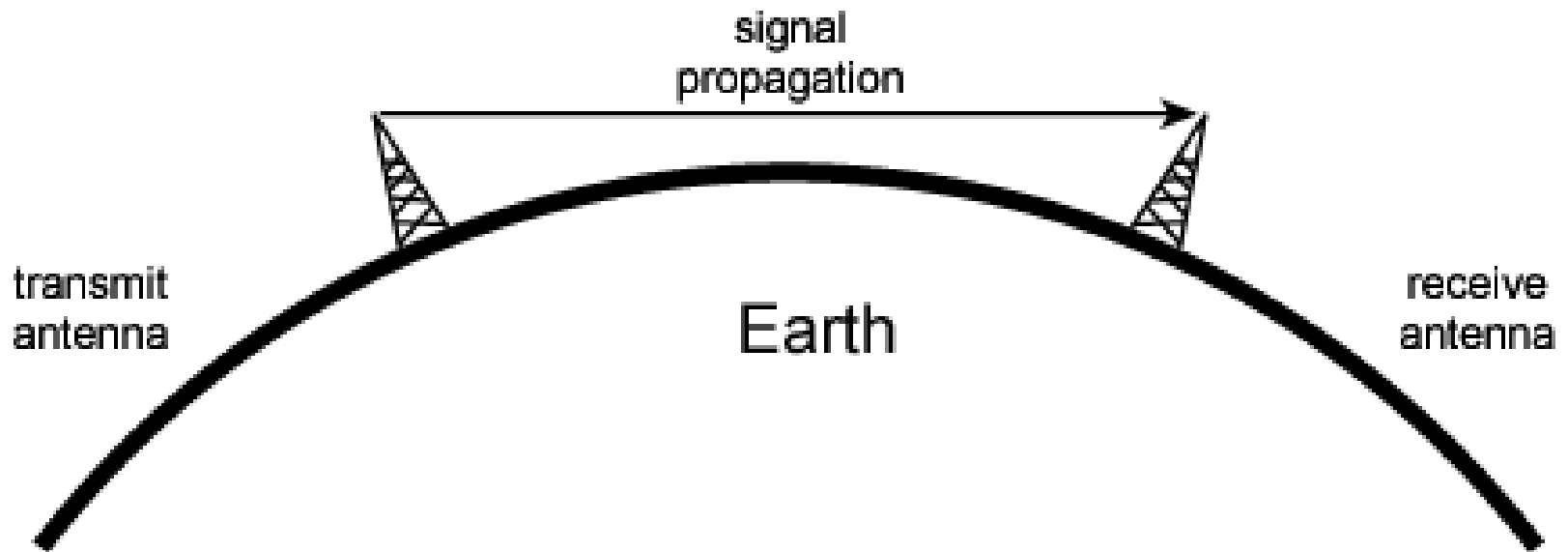

(c) Line-of-sight (LOS) propagation (above 30 MHz)

Refraction

- Velocity of electromagnetic wave is a function of density of material
 - $\sim 3 \times 10^8$ m/s in vacuum, less in anything else
- As wave moves from one medium to another, its speed changes
 - Causes bending of direction of wave at boundary
 - Towards more dense medium
- Index of refraction (refractive index) is
 - $\sin(\text{angle of incidence})/\sin(\text{angle of refraction})$
 - Varies with wavelength
- May cause sudden change of direction at transition between media
- May cause gradual bending if medium density is varying
 - Density of atmosphere decreases with height
 - Results in bending towards earth of radio waves

Optical and Radio Horizons

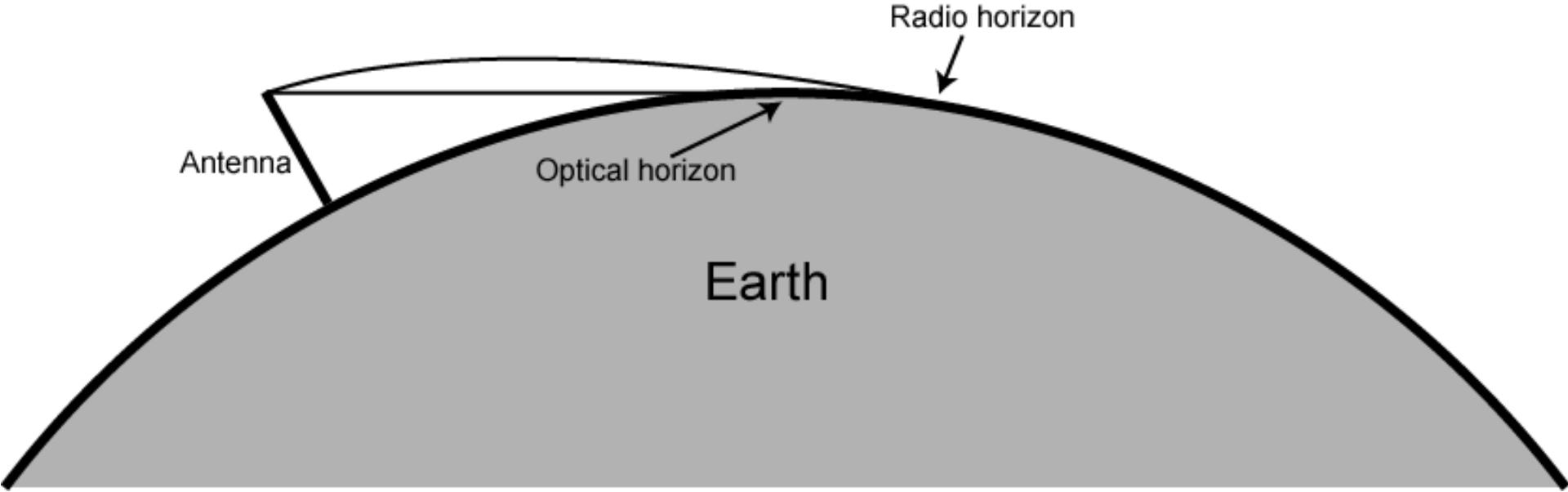

Line of Sight Transmission

- Free space loss
 - Signal disperses with distance
 - Greater for lower frequencies (longer wavelengths)
- Atmospheric Absorption
 - Water vapour and oxygen absorb radio signals
 - Water greatest at 22GHz, less below 15GHz
 - Oxygen greater at 60GHz, less below 30GHz
 - Rain and fog scatter radio waves
- Multipath
 - Better to get line of sight if possible
 - Signal can be reflected causing multiple copies to be received
 - May be no direct signal at all
 - May reinforce or cancel direct signal
- Refraction
 - May result in partial or total loss of signal at receiver

Free Space Loss

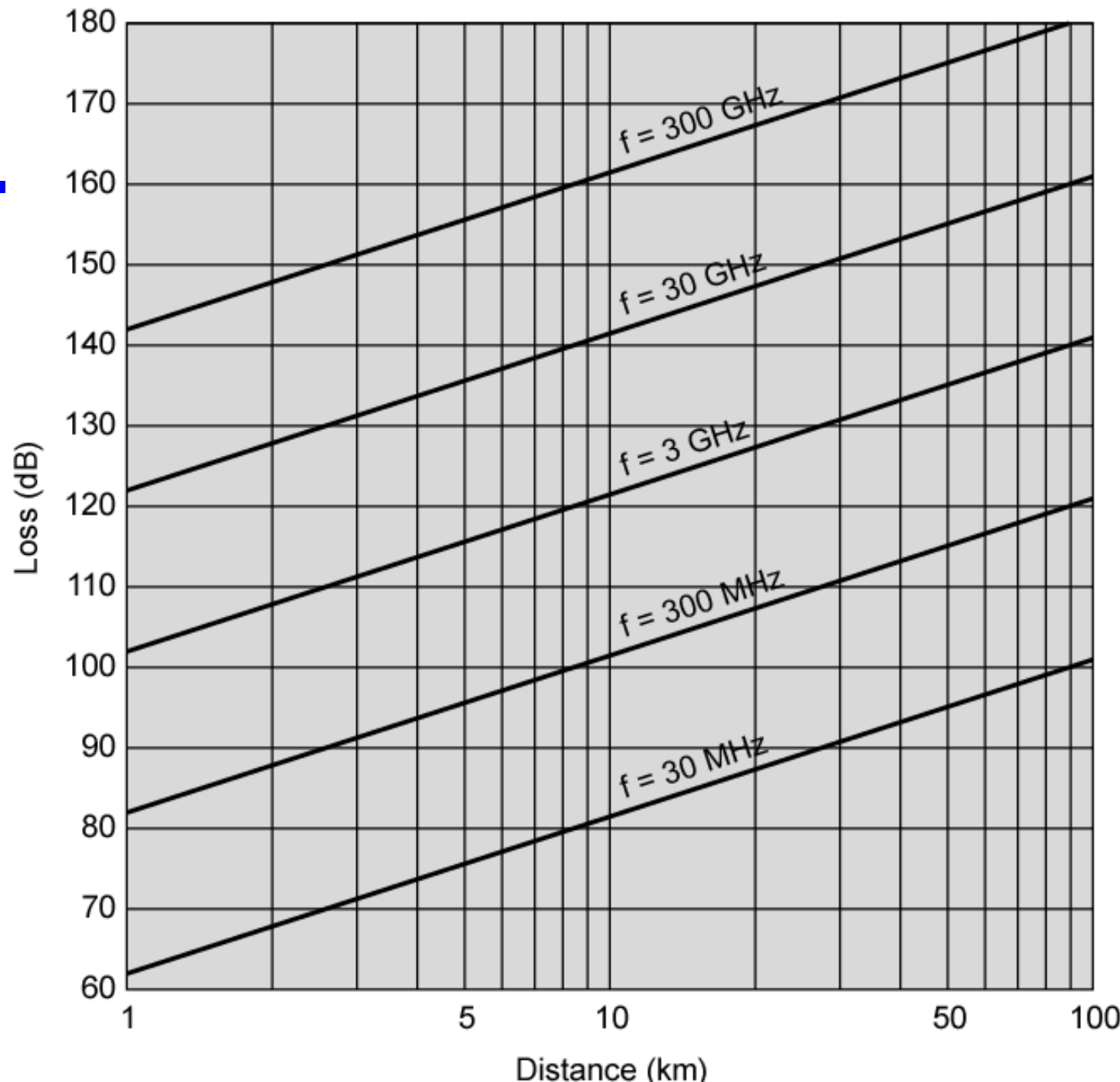

Multipath Interference

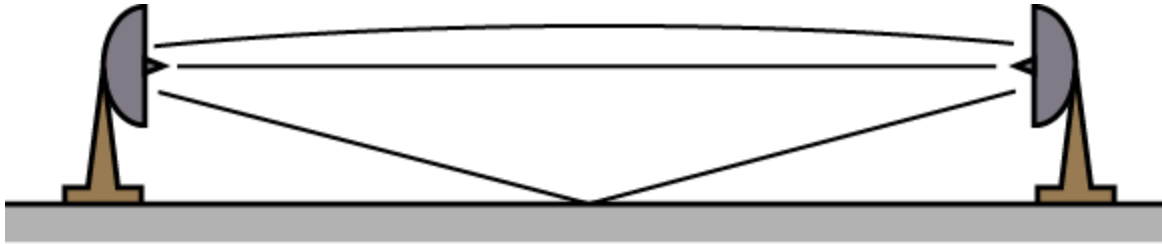

(a) Microwave line of sight

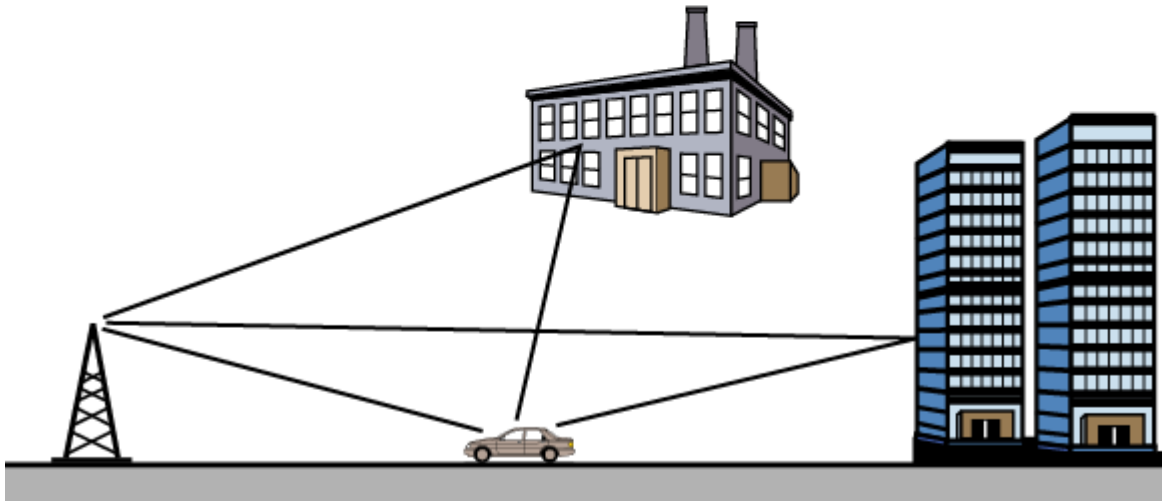

(b) Mobile radio

Required Reading

- Stallings Chapter 4